

## The "NANI" Dockleveller

"NANI" HAVE USED THERE TECHNICAL DEVELOPMENT SKILLS TO PRODUCE NEW ENVIRONMENT FRIENDLY LOADING EQUIPMENT

### The Dockleveller.

The exeptional quality of these new types of dockleveller have been designed by a team of technicians who have many years of experience in the loading equipment field.

The new NANI docklevellers comply with all the european safty standards. Regulation DIN 15126 applies for docklevellers, and ZH 1/156 for docklevellers and mobile ramps. NANI has also used the latest VDE regulations.

### Dockleveller sub-frame.

The steel sub-frame can be installed prior to the dockleveller being placed in position.

Installed in this way it avoids problems of concrete overspill getting into the mechanism of the dockleveller, cylinder rams and seals, Hydraulic components and the electrical equipment.

Protection of the vital components at this stage ensures a longer life for your investment.

The ingress of concrete residue and dust can cause many problems in the early life of a dockleveller if it isn't protected when installation takes place.

### The construction.

The platform is manufactured from high tensile steel tear drop plate with minimum thickness of 8 mm with longitudinal angle supports on the under side. Side supports are of 6 mm thickness. This unit is welded together using the most modern welding techniques. the platform is constructed in such a way that when installed and commisioned into your loading bay, it will adjust itself by way of lateral flexing to any vehicle bed with a sideways slope. After completing a sideways operation the platform will return to the normal horizontal position.

The dockleveller is supplied with large rubber buffers, these being manufactured from recycled material.

Black and yellow warning stripes are painted on the side supports to warn forktruck drivers if a leveller is in the raised position or to show pedestians a warning of either tripping or a danger of foot shear.

The lift cylinders are mounted in pairs, the base being to outer edge of the base frame and the top to the underside of the platform but angled towards the centre. The cylinders are positioned in this way to give a safer balance in the unlikely event of a hydraulic hose failure.

The extending platform is mounted on 6 No. steel rollers each with integrated maintenance free roller bearings. This system ensures smooth and quite movement when either advancing or retracting the platform.

## The hydraulic power pack

This unit is of the compact type and has a 1.5 KW electric motor. The motor is oil submerged which helps to reduce wear and tear on the drive mechanism.

This system also helps to cut the possibilities of the motor overheating. The hydraulic oil is as would used in deep situations.

In all working positions the platform is allowed to float to stay in contact with the vehicle bed. This is controlled through a series of valves in the valve block and electronics in the control box, giving a safe working situation at all time.

## Control Box

The control box has 2 No. push buttons and a lockable isolator switch is also attached.

All functions are controlled via micro-processor, thus giving infinite control of the loading bridge at all time. In turn giving a safer and longer life span to your system.

## Paint finish.

All steel parts are anti-corrosion treated before paint is applied. Paint is applied with a base coat anti-corrosion system and a final top coat to give protection and an eye pleasing finish.

## Optional water soluble paint finish.

This is a 2 component paint system in 100my layers. This paint is the type used on sea going containers and is extemly effective in all working conditions, it is also a completely environment friendly system.

## Design / Construction features of Nani-Docklevellers

1. The Plateau-cover-sheet is made in TR.-Bl. 8/10. (So we prevent deformations of the cover sheet through the little and hard fork-lift wheels with their extensive higher point-strains)
2. The side sheets are 6mm thick sheets. (These sheets increase the stability of the plateau and are much more resistant against deformations than the common used 3-4 mm sheets)
3. Big-dimensioned plateaubearings spreadn the forces at the connection to the hall floor extensively and in that way optimally.
4. The lifting cylinders that are placed far ahead, across the plateau-axis effect the best possible force-abrasive. Through this kind of cylinder placing result no horizontal forces at the connection to the hall floor (as at the common places for the cylinders transversely an parallel to the plateau-axis).  
The cylinder are on both sides bedded in swivel heads / universal joints.
5. This kind of cylinder placing has a special advantage in the so-called emergency-stop case, because high forces have to be transfered into the building especially at this case. Furthermore gets the plateau with the fork-lift truck on it optimally supported through that!
6. The telescopic lip is 6-fold roll-bedded ( that means, that while the forward- and backward- driving of the telescopic lip runs no "steel-on-steel" and so there are no grinding- or squeaking sounds; better corrosion protection, because the varnish-layer does not get damaged; longterm life-span).  
An extremely important aspect of the use in a mixed-use zone is that through that is and extremely quiet working of the dockleveller guaranteed.
7. To this also contributes the serially used under-oil-unit, which guarantees a very quiet engine operation.  
The lower speed is adjustable through a restrict.  
The system gets protected through an adjustable pressure control valve against an overcharge.
8. Serially big-dimensioned buffers ( 450 x 250 x110 ) protect the ramp and the facade much better and longer than the common used little ( i.e. 400 x 80 x 70 ) rubber bars.
9. The cylinders are serially provided with burst pipe protection.

Changes to specification maybe made without prior notification.

Indokor-E



**...for optimal loading**

<http://www.nani.de> E-mail: [info@nani.de](mailto:info@nani.de)

Nani Verladetechnik GmbH & Co. KG  
Siegerslebener Str. 12, D-39365 Eilsleben  
Tel:(039 409)914 0, Fax:(039 409)345

# Zertifikat

Nr.: AL 94 07 18695 001



NANI GmbH & Co. KG

Siegerslebener Str. 12  
39365 Eilsleben

mit der(n) Fertigungsstätte(n)  
18695

ist berechtigt, nachfolgend genanntes Produkt mit den  
**Prüfzeichen A,B oder L**  
gemäß Zeichenliste 01/94 zu kennzeichnen. Umseitige Hinweise sind zu beachten.

Produkt: **Überladebrücken**

Modell: **VB 5 und VB 10**  
**Hydraulische Überladebrücke mit Vorschub**

Kenndaten: VB 5, Zeichnungs-Nr. 14.000.000  
Tragfähigkeit: max. 60 kN  
Vorschublänge: 500 mm  
  
VB 10, Zeichnungs-Nr. 16.000.000  
Tragfähigkeit: max. 60 kN  
Vorschublänge: 1000 mm

Das Produkt entspricht den Anforderungen des deutschen Gerätesicherheitsgesetzes  
und wurde geprüft nach:

ZH1/156 10.88  
DIN 15126 09.89

Bericht Nr.: 02540401101

Freigegeben mit der obigen Zertifikatsnummer durch die  
Zertifizierungsstelle von TÜV PRODUCT SERVICE GMBH.

Organisationseinheit: 2MCH / M.Rattensperger / ra  
Datum: 22.07.94



◆ ZERTIFIKAT ◆ CERTIFICATE ◆ CERTIFICADO ◆ CERTIFICATO ◆ CERTIFICAAT ◆ СВИДЕТЕЛЬСТВО ◆  
◆ ZERTIFIKAT ◆ CERTIFICATE ◆ CERTIFICADO ◆ CERTIFICATO ◆ CERTIFICAAT ◆ СВИДЕТЕЛЬСТВО ◆  
◆ ZERTIFIKAT ◆ CERTIFICATE ◆ CERTIFICADO ◆ CERTIFICATO ◆ CERTIFICAAT ◆ СВИДЕТЕЛЬСТВО ◆

## NANI-Dockleveller With Telescopic Lip Model VB 10

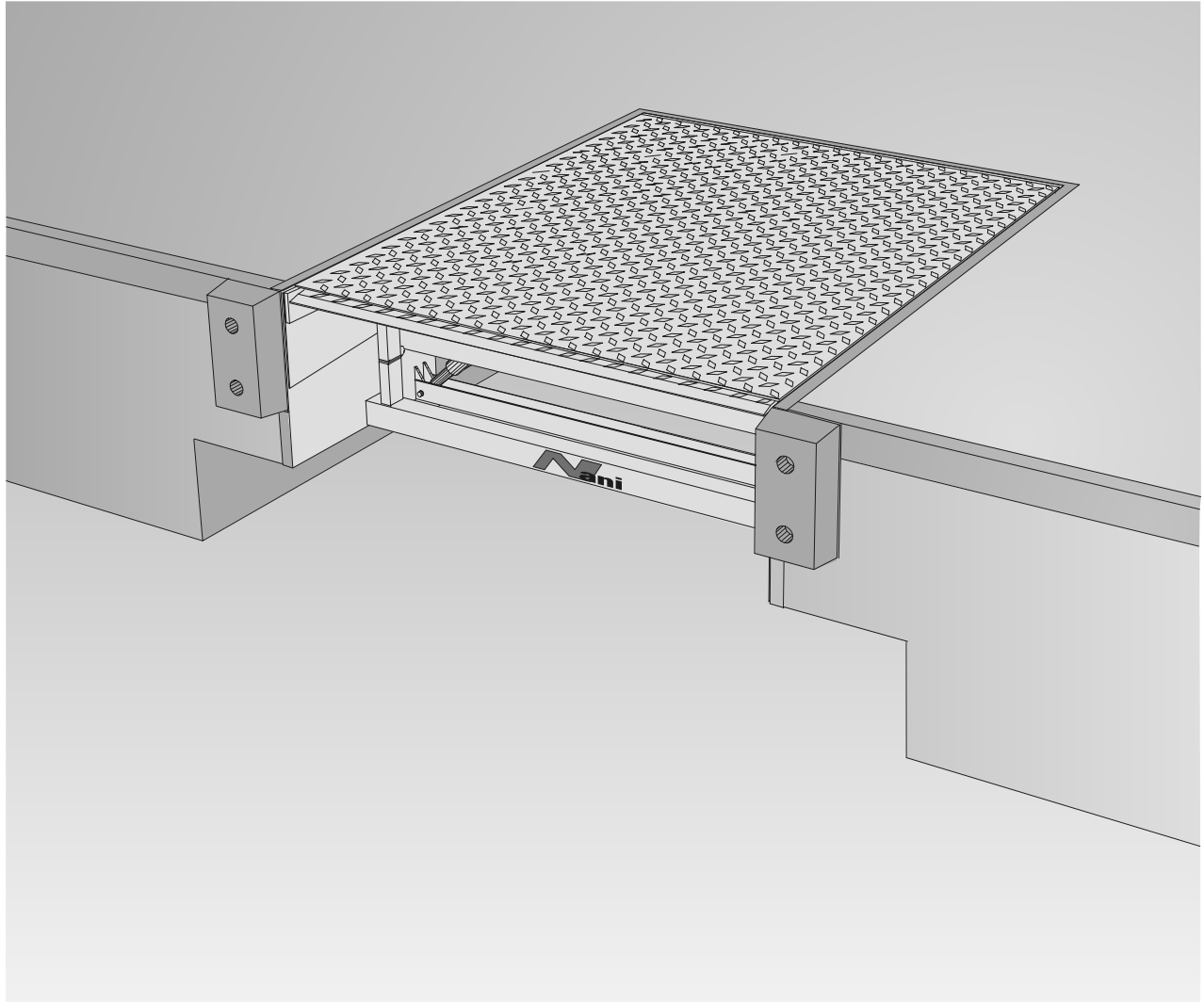

The model VB 10 Dockleveller is high of quality construction and materials. With the very reliable electro-hydraulic operation that gives you infinite control over the placing of the telescopic lip onto the vehicle bed. Goods can be removed from or loaded onto the vehicle with greater ease and less chance of damage. As with all NANI levellers the VB 10 platform will float down onto the vehicle bed and take up any side tilt required to give a safe surface to work over

and allow the fluctuations that are likely to occur when loading or offloading vehicles. Should a vehicle pull away during loading with a fork truck actually on the platform the emergency stop will take over and stop the leveller falling to a lower level. Therefore avoiding a serious accident and injury to the fork truck operator. The VB 10 is designed to carry up to it's designed capacity in the cross traffic position (rest position).

**The VB 10 is manufactured to comply with the regulation for Docklevellers and mobile ramps ZH 1/156 and Euro-Norm EN 1398.**

Changes to specification maybe made without prior notification.

V12-9/05-E

**Nani**  
VERLADETECHNIK

**...for optimal loading**  
<http://www.nani.de> E-mail: [info@nani.de](mailto:info@nani.de)

Nani Verladetechnik GmbH & Co. KG  
Siegerslebener Str. 12, D-39365 Eilsleben  
Tel:(039 409)914 0, Fax:(039 409)345

# NANI-Dockleveller With Telescopic Lip Model VB 10

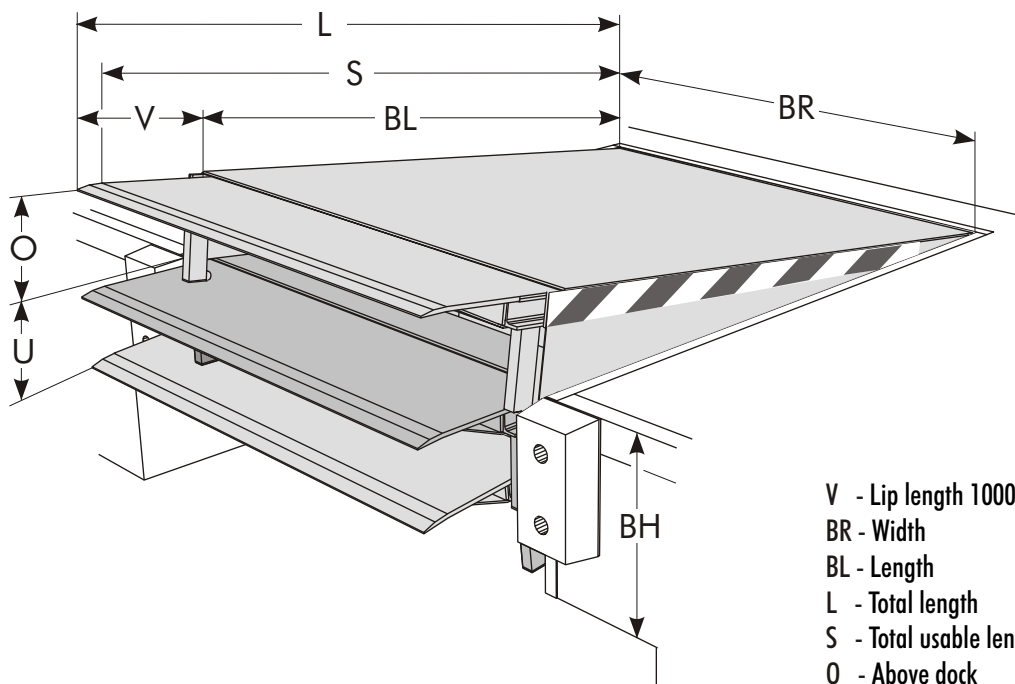
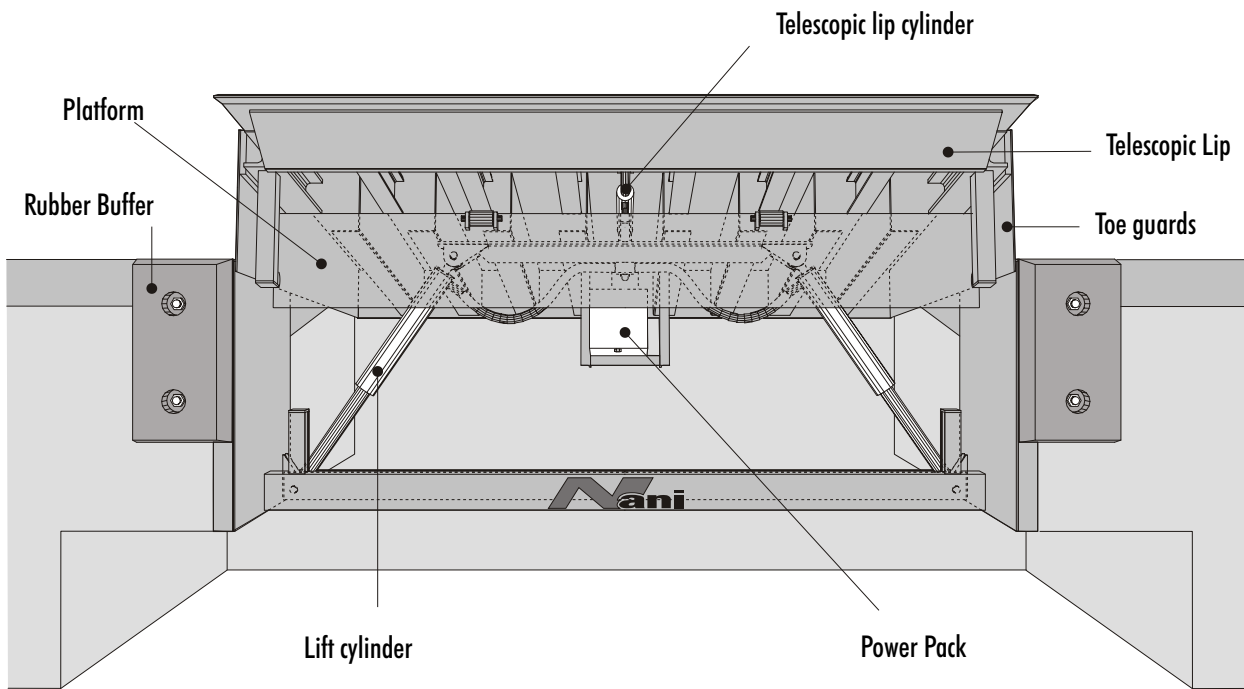

**V** - Lip length 1000; for Size 1 840  
**BR** - Width  
**BL** - Length  
**L** - Total length  
**S** - Total usable length  
**O** - Above dock  
**U** - Below dock  
**BH** - Depth of leveller

Sizes	BR	BL	L	S	O	U	BH
1	2000	2000	2840	2740	340	340	700
2	2000	2500	3500	3400	420	420	700
3	2000	3000	4000	3900	480	450	800
4	2000	4000	5000	4900	600	450	900

Load capacity for all sizes 40 kN or 60 kN.  
 Please ask for assistance on capacity  
 and size to suit your application.

Changes to specification maybe made without prior notification.

V11-2405-1-E



**...for optimal loading**

<http://www.nani.de> E-mail: [info@nani.de](mailto:info@nani.de)

Nani Verladetechnik GmbH & Co. KG  
 Siegerslebener Str. 12, D-39365 Eilsleben  
 Tel: (039 409)914 0, Fax: (039 409)345

### OPERATING INSTRUCTIONS TELESCOPIC LIP DOCKLEVELLER

- Press "RAISE" button, dockleveller will lift. When in "LIP OUT" position lip will retract

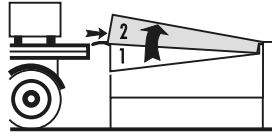

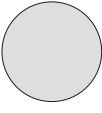

**RAISE**

- Press "LIP OUT" button, lip will move forward until button is released, dockleveller will float down onto vehicle bed.

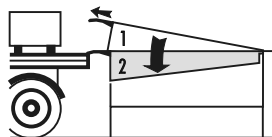

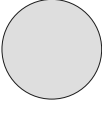

**LIP OUT**

- Press "AUTO-PARK" button once and release, dockleveller will automatically return to parked position

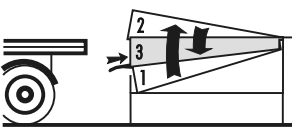

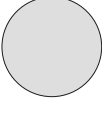

**AUTO-PARK**

**ATTENTION !**

1. Park vehicle on the loading bay.
2. Only operate dockleveller when it is clear and safe to do so.
3. The main isolator switch must be in the "ON" position at all times during loading or unloading.
4. The dockleveller platform must be in contact with the vehicle bed at all times during loading or unloading.
5. In an emergency isolator switch must be turned to the "0" position.
6. Service and repairs to the dockleveller must be carried out by qualified staff and with extreme care. Always use the safety prop when working under the dockleveller.

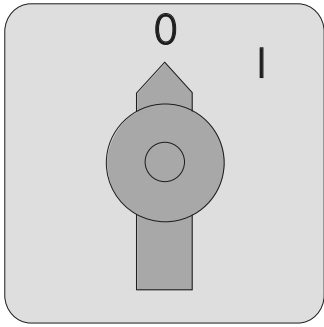

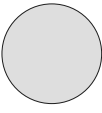

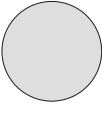

**DOOR DOWN**

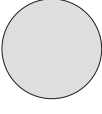

**DOOR STOP**



**DOOR OPEN**



Nani Verladetechnik GmbH & Co. KG  
 Siegerslebener Str. 12, D-39365 Eilsleben  
 Tel:(039 409)914 0, Fax:(039 409)345

pst42410-E

Changes to specification maybe made without prior notification.

Base control telescopic lip dockleveller with Auto-Park and integrated door control.  
 Auto-Park and integrated door control optional.